

# MINI BLINDS Classic

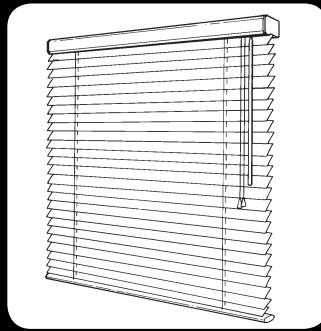

**3DAYBLINDS®**  
YOU'LL LOVE THE TREATMENT

## GETTING STARTED

A few simple tools are required:



Steel Tape Measure



Pencil

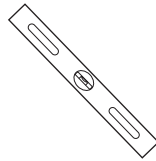

Level



Power Drill and  
Drill Bits



Flathead & Phillips  
Screwdriver



Awl (or tool for  
starting a screw hole)

Included in your order is all the hardware necessary for a normal installation. Depending on the mounting surface, fasteners other than the screws provided may be required. Wall board and plaster require the use of anchors such as expansion or toggle bolts. Bricks, tile and stone need special plugs and drill bits. Wood should always be pre-drilled to avoid splitting.

Professional installation is also available in most areas, call 800-800-3329.

## STANDARD HARDWARE

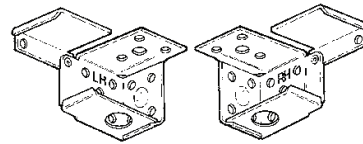

End Brackets  
(Open Position LH & RH)

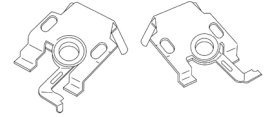

Top Brackets

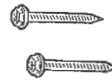

Screws



Valance Clip



Center Support

## OPTIONAL HARDWARE

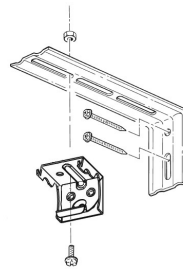

Extension Bracket

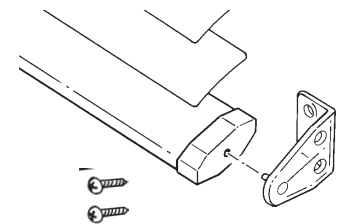

Hold Down Brackets  
with Screws

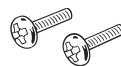

Phillips Machine  
Screws



Hex Machine  
Nuts

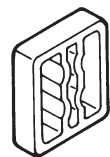

Spacers

# INSIDE MOUNT

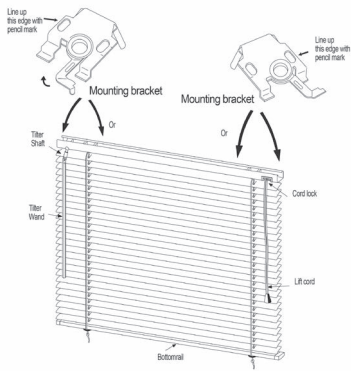

- With the blind fully opened, hold it up to wall in the position it will hang. Make sure the blind is centered left and right and the height is correct. Make sure the blind is level.

- Make pencil marks 1/4" past each end of the headrail.

- Place each mounting bracket in a level position on the pencil marks with the large hole facing the floor.

- Mount each bracket with two screws.

## TO INSTALL CENTER SUPPORT BRACKET(S):

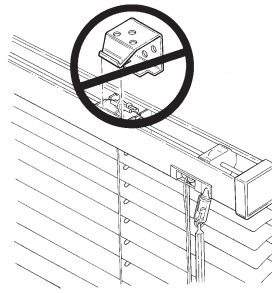

- If your hardware packet includes one center support bracket, position it as close to the center of the window casing as possible, making sure that it will not interfere with any moving parts. If more than one center support bracket has been provided, position them equidistant from the end brackets and each other, again avoiding all moving parts.

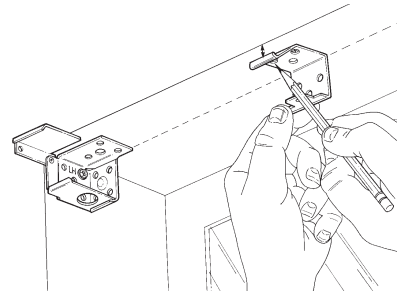

- Align the back of the center support bracket with the back end of the mounting bracket. The alignment is crucial for proper blind installation.
- Using a pencil, mark the window casing through the holes in the top of the center support bracket. For maximum stability, the pencil marks should be made in the two holes at the front of the bracket.

- Using a drill with a 1/16" drill bit or an awl, make a small pilot hole at each pencil mark.

- Mount the bracket using two of the screws provided.
- Repeat this procedure for any remaining center support brackets.

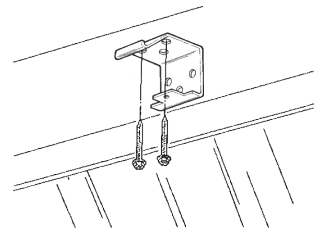

Proceed to "Blind Installation".

# INSIDE MOUNT WITH END BRACKETS

- Mount a bracket in each corner of the window.

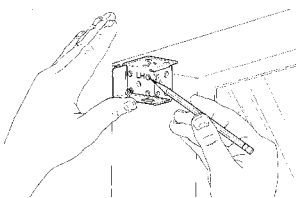

- Position the front edge of the closed end bracket flush with the front edge of the window casing to mark the screw holes.

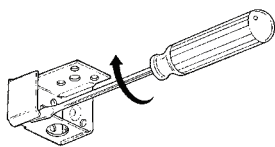

- To open the latch of the end bracket use a flathead screwdriver as shown.

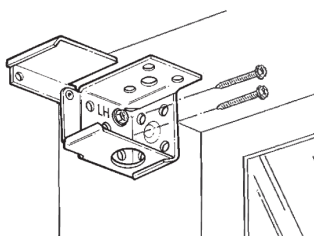

- Mount each bracket with two screws.

# OUTSIDE MOUNT

## TO INSTALL THE END MOUNTING BRACKETS:

- Unwrap the cellophane from around the blind stack.  
Caution: DO NOT cut the cellophane as the cords or ladders supporting the blind may be inadvertently cut.
- Lower the blind to its full length. (See “Blind Operation”)

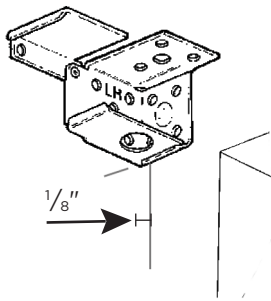
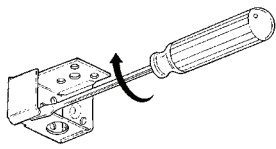
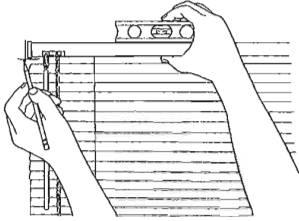

1/8"

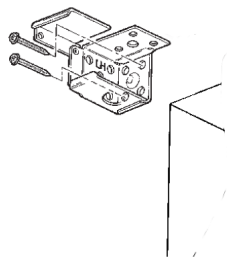

- Hold the blind up to the desired mounting position.
- Once the blind is level, mark the wall at the lower corners of each end of the headrail using a pencil
- Draw the blind completely up and set it aside.
- Using a flathead screwdriver, open the latches of the end brackets.
- Facing the window, position the end bracket marked “LH” above the top left corner of the window, 1/8" TO THE LEFT of the pencil marks.
- Using a pencil, mark the wall through the holes in the back of the end bracket. For maximum stability, the pencil marks should be made diagonally.
- Using a drill with a 1/16" drill bit or an awl, make a small pilot hole at each pencil mark.
- Mount the bracket using two of the screws provided.
- Repeat this procedure for the right end bracket, making sure the end bracket marked “RH” is positioned above the top right corner of the window, 1/8" TO THE RIGHT of the pencil marks.

## TO INSTALL CENTER SUPPORT BRACKET(S):

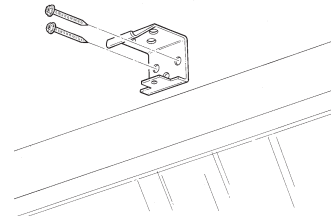
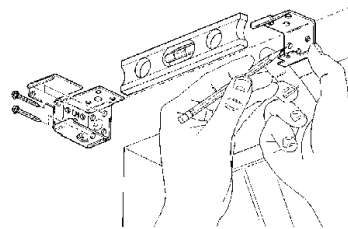
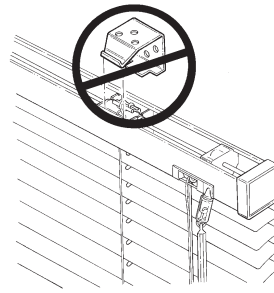

- If your hardware packet includes one center support bracket, position it as close to the center of the mounting surface as possible, making sure it will not interfere with any moving parts. If more than one center support bracket has been provided, position them equidistant from the end brackets and each other, again avoiding all moving parts.
- Make sure all center support brackets are positioned at the same height and are level with the end brackets.
- Using a pencil, mark the mounting surface through the holes in the back of the center support bracket. For maximum stability, the pencil marks should be made in the top two holes of the center support bracket.
- Using a drill with a 1/16" drill bit or an awl, make a small pilot hole at each pencil mark.
- Mount the bracket using two of the screws provided.
- Repeat this procedure for any remaining center support bracket(s).

Proceed to “Blind Installation”.

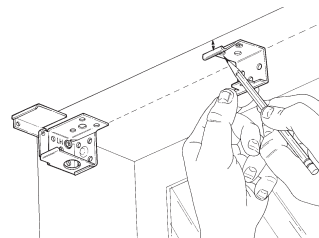

# BLIND INSTALLATION

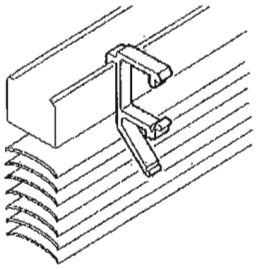

- If you ordered the blind with a valance, snap the valance clips to the front of the headrail before installing the blind. The valance clips should be spaced equidistant from the end brackets and each other to allow proper support for the entire valance. Make sure that the Valance Clips do not interfere with any moving parts. You will install the valance slat after the blind is in place.

- If you have not already done so unwrap the cellophane from around the blind stack. Caution: DO NOT cut the cellophane as the cords or ladders supporting the blind may be inadvertently cut.

## TOP MOUNT BLIND INSTALLATION

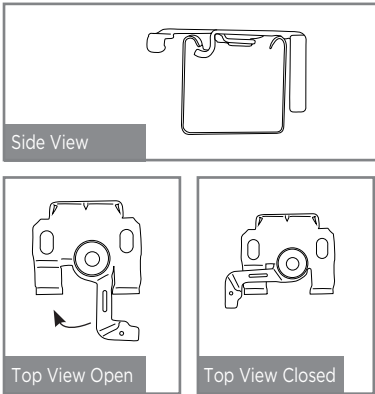

- Be sure the hinged doors on the brackets are in the open position.
- Slide the headrail into the mounting brackets until the front of the bracket hooks under the inside front part of the headrail.
- Close the hinged doors on the brackets.

## END MOUNT BLIND INSTALLATION

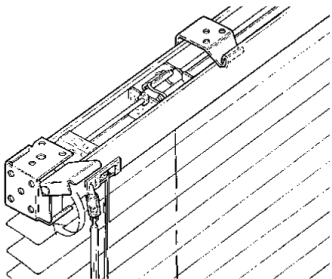

- Be sure the hinged end brackets are in the open position.
  - Hook the front edge of the headrail onto the lip of the center support bracket(s), if applicable. Insert the headrail into the end brackets, making sure that no cords or slats are in the way.
  - Close the hinges on the end brackets until you hear them “snap.”
- While supporting the bottom of the blind, unwind the draw cords and gently lower the blind to its full length. (See “Operating the Blind”.)

NOTE: If the bracket interferes with any of the working parts, the incorrect holes of the end mount bracket may have been selected.

# VALANCE INSTALLATION

Make sure the valance clips have been attached to the headrail as noted in “Blind Installation”.

## INSIDE MOUNT VALANCE INSTALLATION

1. Insert the top of the valance into the top lip of the valance clips.
2. Gently lift the top lip of the valance clip and snap the middle into the center lip of the valance clips. (See Figure A)

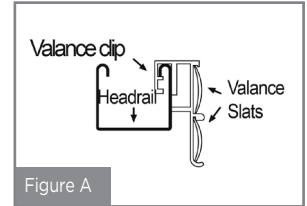

## OUTSIDE MOUNT VALANCE INSTALLATION

NOTE: The outside Contempo Valance requires the return ends to be formed into position. To do this:

1. Make Sure the slats are evenly spaced inside the valance.
2. On the back of the valance, locate the notches approximately 4” in from each end. If extension brackets are used, the notch will be further from the end.
3. At the notch, bend the return at one end of the valance all the way over to crease (See Figure B1) and then back halfway to form a 90° angle. (See Figure B2)
4. Repeat for the other end of the valance.
5. Install the valance per the “Inside Mount Valance Instructions” provided above.

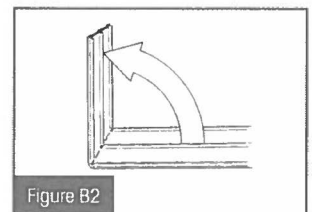
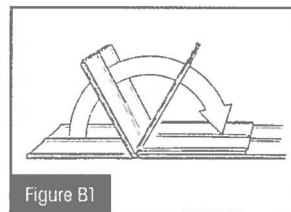

## BLIND OPERATION

To lower the blind, pull the lift cords down and toward the center of the blind and allow the cords to slide slowly through your hand.

To tilt the slats, twist the tilt wand.

Do not attempt to raise or lower the blind unless the slats are in a completely open (horizontal) position.

To raise the blind, pull the lift cords down.

To engage the lock, pull the lift cords down and towards the outside of the blind.

## BLIND REMOVAL

End Mount

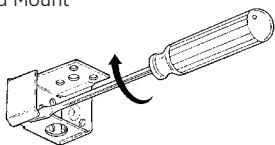

- Using a flathead screwdriver, open the latches of the brackets.

Top Mount

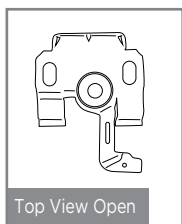
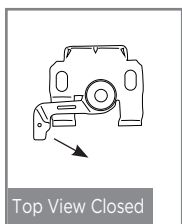

- Holding on to both ends of the headrail, gently pull the blind forward and out of the brackets making sure to unhook the headrail from the center support bracket(s), if applicable.
- To remove rail from top mount brackets move the lever from the closed position to the open position.

## OPTIONAL HARDWARE INSTALLATION

### SPACERS

Available for use on windows with a projected molding. They are  $\frac{3}{8}$ " thick and allow the blind to be mounted flush with the outside edge of any standard window molding.

Spacers

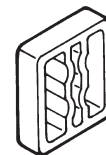

Spacers are available by contacting our Client Care Team at 800-800-2239.

### HOLD DOWN BRACKETS

Hold down brackets are used primarily on shades being mounted to doors or in motor homes. (2 per blind) Hold Down Brackets are available by contacting our Client Care Team at 800-800-3329. There is a small hole in the center of the end cap that is covered by a thin plastic cover. Use the pin of the hold down bracket to push through the center of the end cap and it will break through the plastic cover.

- With the blind lowered to its full length, place the pin of each hold down bracket into the hole in each end of the bottom rail.
- Using a pencil, mark the mounting surface through the holes in the hold down bracket. Make sure the hold down brackets are level and aligned with each other.
- Raise the blind and screw the hold down brackets into the mounting surface using the screws provided.

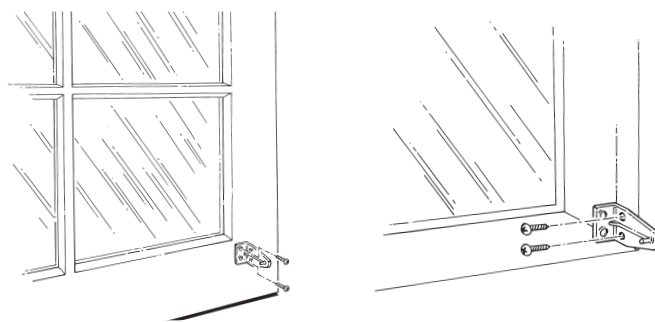

- Mount the hold down bracket to the side or back of the window frame so that the pin lines up with the front hole in the bottom rail end cap with the blind fully lowered.

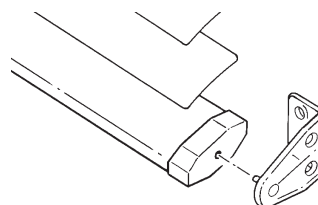

- Lower the shade and flex the hold down bracket outward so that the pin can be inserted into the hole in the end cap.



## WARNING

Young children can STRANGLE in cord and bead chain loops. They can also wrap cords around their necks and STRANGLE.



- Always keep cords and bead chains out of children's reach.
- Move cribs, playpens, and other furniture away from cords and bead chains. Children can climb furniture to get to cords.
- Do not tie cords together. Make sure cords do not twist together and create a loop.

ANSI/WMCA A100.1-2014 5.2.1

Inner cords can pull out to form a loop, which can strangle a young child.

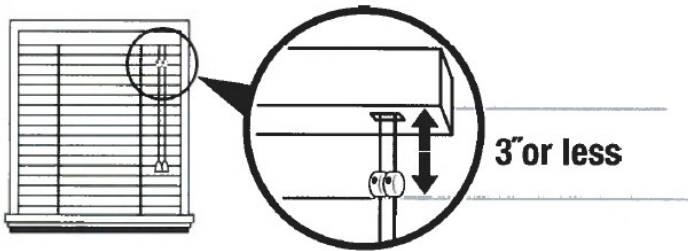

- Inner cord stop devices can reduce this risk if positioned correctly on the pull cords.
- If inner cord stop devices are more than 3 in (76 mm) below the headrail when the blind is fully lowered, move them closer by loosening, but not untying, the knot surrounding the cord stop, and sliding the cord stop upwards. Repeat for any remaining cords.



**3DAYBLINDS®**  
YOU'LL LOVE THE TREATMENT

800-800-3329 | 3dayblinds.com