

WOVEN WOOD SHADES

Corded, Continuous Cord Loop or Upended

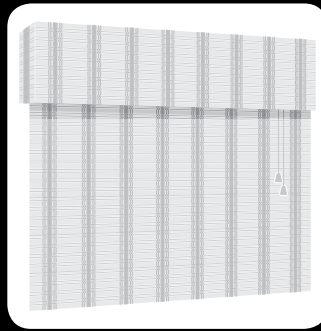

3DAYBLINDS®
YOU'LL LOVE THE TREATMENT

GETTING STARTED

A few simple tools are required:



Steel Tape Measure



Pencil

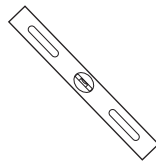

Level (for outside mount)



Power Drill and
1/8" Drill Bit



Phillips Screwdriver



Awl (or tool for
starting a screw hole)

Included are the screws needed for a normal installation. Depending on the mounting surface, fasteners other than the screws provided may be required. Wallboard and plaster require the use of anchors such as expansion toggle bolts. Bricks, tile and stone need special plugs and drill bits. Wood should always be pre-drilled to avoid splitting.

Professional installation is also available at most 3 Day Blinds locations.

HARDWARE INFORMATION

The hardware you received with your product are REQUIRED for proper installation.

If brackets were supplied, they should be installed at each end between end cap and the flat part of the cord spool. Any additional brackets will need to be evenly spaced between the two end brackets.

NOTE: Do not mount brackets over the flat part of the cord spools, improper placement of the brackets can result in poor operation of the shade.

INSIDE MOUNT

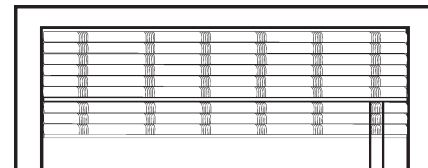

INSIDE MOUNT HEADRAIL INSTALLATION

- Facing the window, position the bracket 1 1/8" in from the left corner of the window casing.
- Using a pencil, mark the wall through the holes in the top of the bracket.
- Using a drill with a 1/16" drill bit or an awl, make a small pilot hole at each pencil mark.
- Mount the bracket using the screws provided.
- Repeat this procedure for the right bracket, making sure the bracket is 1 1/8" in from the right corner of the window casing.
- Repeat this procedure for any remaining brackets. Make sure the brackets are evenly spaced throughout the opening.

STANDARD HARDWARE



Mounting Bracket
(for each 1 wing nut
and 2 screws)



Cord Cleats
(2 screws and 2 cleats included)
for corded control

CONTINUOUS CORD LOOP

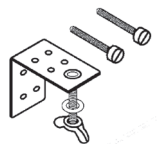

Mounting Bracket
(for each 1 wing nut
and 2 screws)



Tension Pulley
(2 screws and 1
peg included)

UPENDED



3" Screw
(quantity supplied
varies, based on size)



Cord Cleats
(2 screws and 2 cleats included)
for corded control

SIDE MOUNT

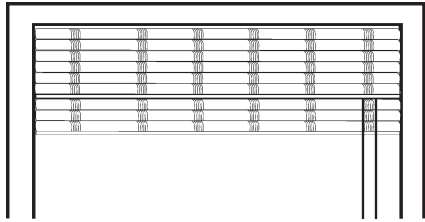

SIDE MOUNT HEADRAIL INSTALLATION

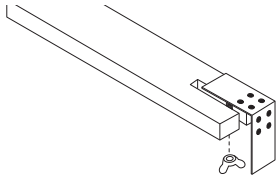

- Attach all mounting brackets to the headrail by placing the bolt on the mounting bracket through the slot in the top of the shade and loosely securing it with the wing nut.

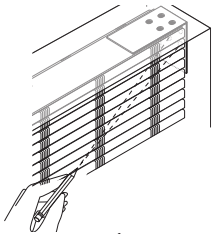

- Hold the shade up to the desired mounting position and mark the drill holes at the side of the bracket.

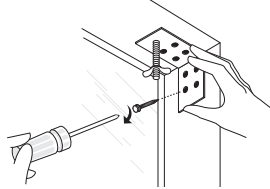

- Remove the brackets from the shade and secure them at the pencil marks using the screws provided. Drill a small pilot hole as required.

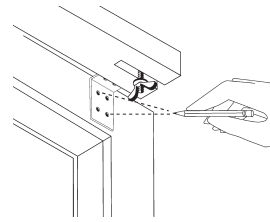

- Hold the shade up to the desired mounting position and mark the drill holes at the top of the bracket.

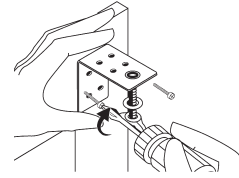

- Remove the brackets from the shade and secure them at the pencil marks using the screws provided. Drill small pilot hole as required.

SHADE INSTALLATION

Place the shades into the mounting brackets and securely tighten the wing nut.

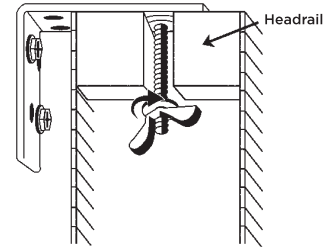

OUTSIDE MOUNT

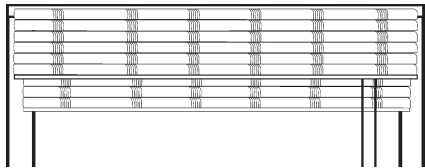

OUTSIDE MOUNT HEADRAIL INSTALLATION

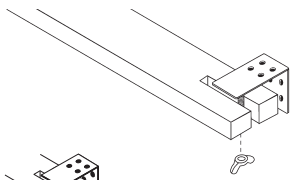

- Attach all mounting brackets to the headrail by placing the bolt on the mounting bracket through the slot in the top of the shade and loosely securing it with the wing nut.

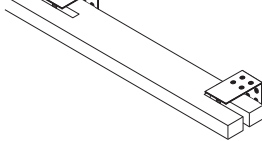

NOTE: Wide shades require center support brackets slots are pre-drilled in headrail.

UPENDED HEADRAIL INSTALLATION

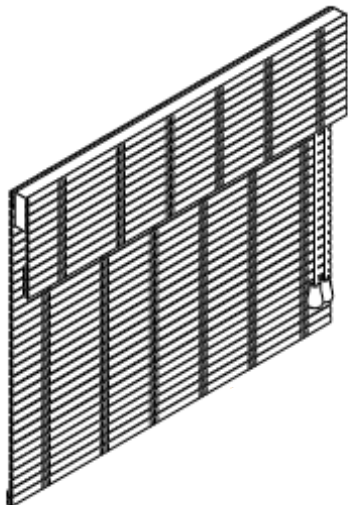

INSIDE TOP MOUNT

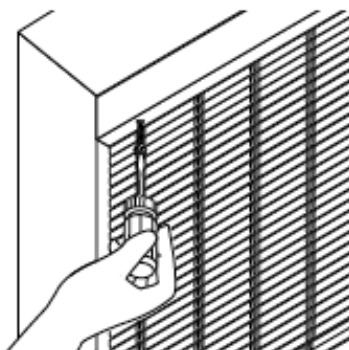

- For Upended Headrail being Inside Top Mounted, lift up shade valance so you have an unobstructed view and align holes in bottom of the headrail with drilled holes. install mounting screws.

OUTSIDE TOP MOUNT

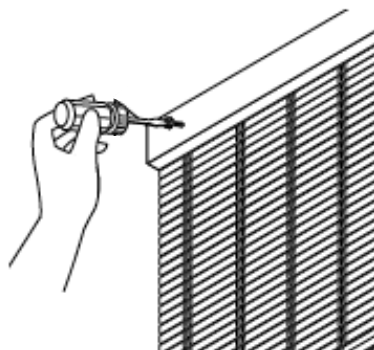

- For Upended Headrail being Outside Mounted, lift up shade valance, align holes in the front of the headrail with drilled holes. install mounting screws.

ATTACHING SAFETY DEVICES

CORDED CONTROL - CORD CLEATS

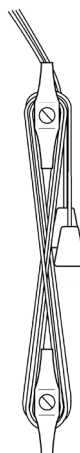

- To reduce the possibility of strangulation, all cords must be kept out of the reach of children, including infants. Installing and utilizing cord cleats are an effective way to implement this essential precaution. Attach the two cord cleats approximately 6" apart at a height where they will be out of the reach of children.
- Once the cleats are attached, simply wrap the excess cord around them after each use of the shade.

TENSIONER INSTALLATION

After installing the window covering, the Cord Tensioner must be mounted for the window covering to operate correctly. When properly installed, the Cord Tensioner functions as a safety device that makes the pull cord less accessible to children.

NOTE: If the mounting screws will not be secured into a wood stud, use wall anchors. For metal surfaces, pre-drill the holes and use sheet metal screws.

IMPORTANT!

- Install the Cord Tensioner in a location that minimizes accessibility to children and pets and where it will not interfere with its operation.
- Only supplied Cord Tensioners and hardware should be used.

MOUNTING OPTIONS

Option A - Inside mount without a bracket

Cord Tensioner used in an inside mount application without a mounting bracket.

- Locate the Cord Tensioner as close to the window as possible to minimize accessibility by children and pets. Be sure the Cord Tensioner is not placed in the path of the window covering when raising and lowering.

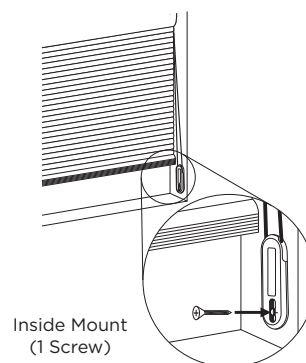

Option B - Inside mount with a bracket

Cord Tensioner using the mounting bracket in and inside mount application.

- Locate the Cord Tensioner as close to the window as possible to minimize accessibility by children and pets. Be sure the Cord Tensioner is not placed in the path of the window covering when raising and lowering.

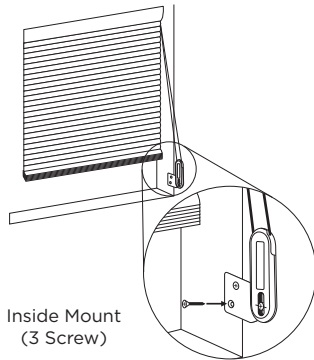

Option C - Outside mount

Cord Tensioner using the mounting brackets in an outside mount application.

- Locate the Cord Tensioner as close to the window as possible to minimize accessibility by children and pets. Be sure the Cord Tensioner is not placed in the path of the window covering when raising and lowering.

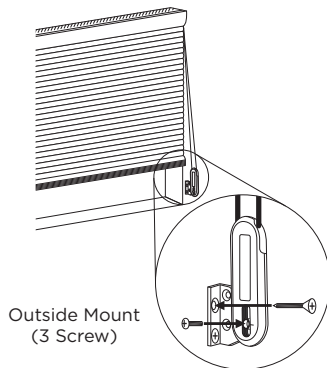

MOUNTING

Option A - Inside mount without a bracket

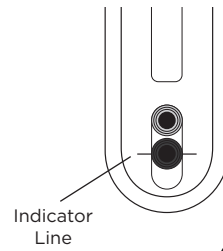

- To release the lock and engage the spring, use an awl, punch or small tip screwdriver to pull down the screw hole, so its center aligns with the indicator line on the Cord Tensioner.

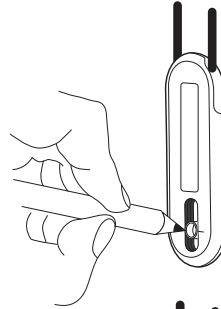

- Mark this location on the wall.

- Pre-Drill the holes for screws and anchors. For applications requiring anchors, use a $7/32$ " frill bit. For applications not requiring anchors, use a $3/32$ " drill bit and drill $1\ 1/4$ " deep. If using anchors, tap them into the holes.

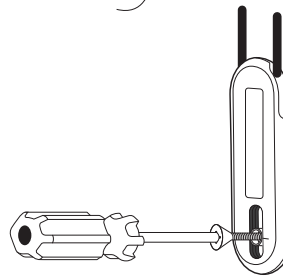

- Use a Phillips screwdriver and one of the longer screws provided to attach the Cord Tensioner directly to the wall.

Option B or C

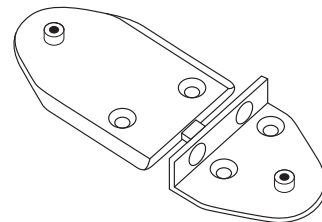

- Break off the bracket needed.

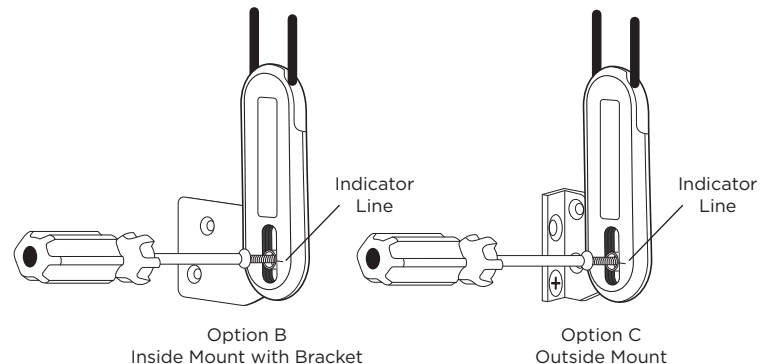

- Attach the bracket to the mounting bracket to the Cord Tensioner. The screw hole in the Cord Tensioner fits into the nub on the bracket.

- Release the lock and engage the sprint by pulling the bracket downward so the center of the screw hole aligns with the indicator line on the Cord Tensioner. Mark the mounting bracket screw locations.

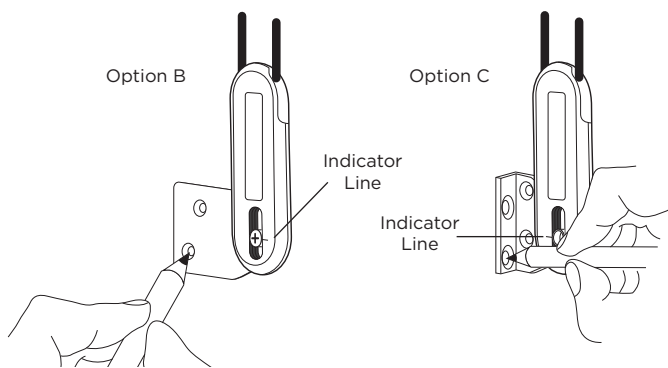

NOTE: Hold the mounting bracket firmly in place and check that the cord can move freely through the Cord Tensioner. If it cannot, the cord is too tight and the mounting bracket should move up. If the cord locks within the Cord Tensioner, the cord is too loose and the mounting bracket should be moved down.

- Pre-Drill the holes for screws and anchors. For applications requiring anchors, use a $\frac{7}{32}$ " frill bit. For applications not requiring anchors, use a $\frac{3}{32}$ " drill bit and drill $1\frac{1}{4}$ " deep. If using anchors, tap them into the holes.

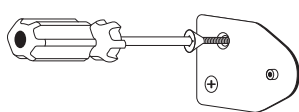

Option B

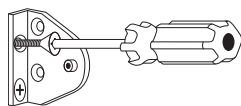

Option C

- Detach the Cord Tensioner from the mounting bracket by removing the small screw. Using a Phillips screwdriver and the two longer screws provided to mount the brackets to the wall.

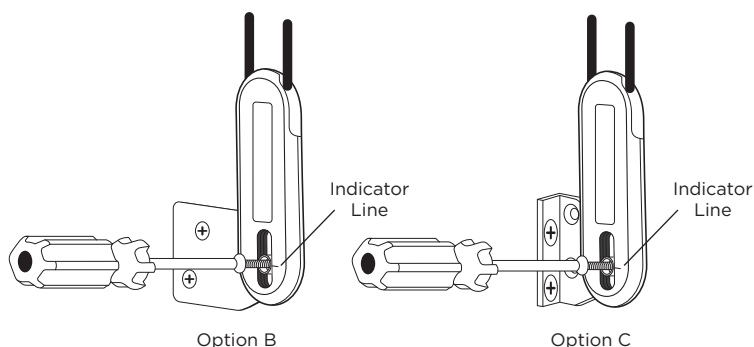

Option B

Option C

- Attach the bracket to the mounting bracket to the Cord Tensioner. The screw hole in the Cord Tensioner fits into the nub on the bracket.

FINAL INSPECTION

Ensure the cord can move freely through the Cord Tensioner without engaging the lock. The center of the screw hole should be at least half way down the slot, aligned with the indicator line on the Cord Tensioner.

CAUTION: Do not put the screw hole all the way to the bottom of the slot as this may cause the cord to become too tight and increase cord wear.

SHADE OPERATION

CORDED CONTROL

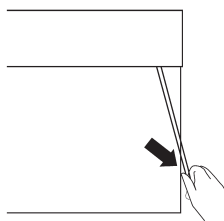
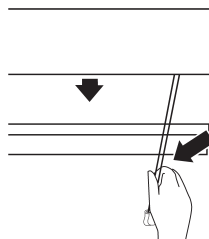

- To lower the shade, hold all of the cords and pull the cords down slightly toward the center of the shade. While holding the cord toward the center of the shade, let the cord run through your hand and lower it to the desired position. Lock the cord into position by moving it to the outside of the shade and releasing it to lock it into place.
- To raise the shade, hold all of the cords and pull until the shade is at the desired height. Lock the cord into position by moving it to the outside of the shade and releasing it to lock it into place.

NOTE: For Top Down and Top Down Bottom Up, if you ordered Top Down only, the cord control will lower and raise the shade from the top down. Top Down Bottom Up shades will have two sets of controls; one to raise and lower the shade as described in Corded Control and the other to raise and lower from the top down. In either case, the cords operate as corded.

CONTINUOUS CORD CONTROL

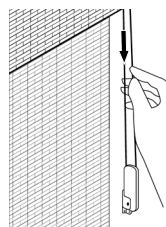
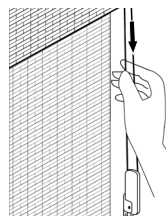

- To lower the shade, pull down on the cord. Continue to pull the cord down until the shade is at the desired height.
- Raise the shade by pulling the opposite side of the cord.

SHADE REMOVAL

Hold shade securely and loosen and remove wing nut.

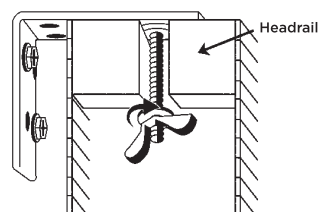



WARNING

Young children can STRANGLE in cord and bead chain loops. They can also wrap cords around their necks and STRANGLE.



- Always keep cords and bead chains out of children's reach.
- Move cribs, playpens, and other furniture away from cords and bead chains. Children can climb furniture to get to cords.
- Do not tie cords together. Make sure cords do not twist together and create a loop.

ANSI/WMCA A100.1-2012 5.2.1

Young children can STRANGLE in cord and bead chain loops and in the loop(s) above the cord connector. They can also wrap cords around their necks and STRANGLE.



- Always keep cords and bead chains out of children's reach.
- Move cribs, playpens, and other furniture away from cords and bead chains. Children can climb furniture to get to cords.

ANSI/WMCA A100.1-2012 5.2.3

This product contains accessible cords on the back. Accessible cords on the back of Roman Style shades can be pulled out to form a loop, which can STRANGLE a young child.

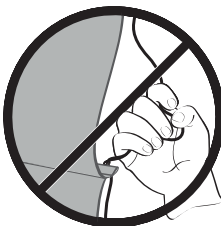

- Children can climb furniture to access lift cords. Move cribs, playpens, and other furniture away from window coverings.

ANSI/WMCA A100.1-2012 5.2.9

Inner cords can pull out to form a loop, which can strangle a young child.

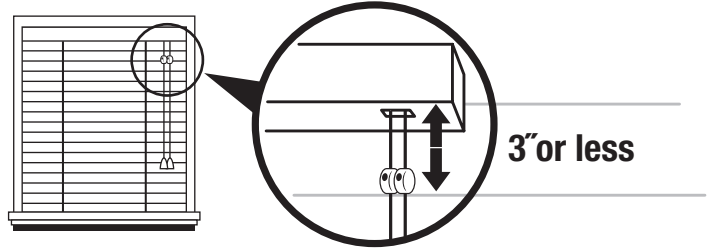

- Inner cord stop devices can reduce this risk if positioned correctly on the pull cords.
- If inner cord stop devices are more than 3 in (76 mm) below the headrail when the blind is fully lowered, move them closer by following the inner cord stop device adjustment instructions.

ANSI/WMCA A100.1-2012 5.3.1.1

Young children can STRANGLE in cord and bead chain loops. They can also wrap cords around their necks and STRANGLE.



- Always keep cords and bead chains out of children's reach.
- Move cribs, playpens, and other furniture away from cords and bead chains. Children can climb furniture to get to cords.
- Attach tension device to wall or floor. This can prevent children from pulling cords and bead chains around their necks. Fasteners provided with the tension device may not be appropriate for all mounting surfaces. Use appropriate anchors for the mounting surface conditions.

ANSI/WMCA A100.1-2012 5.2.4



3 DAY BLINDS®
 YOU'LL LOVE THE TREATMENT
 800-800-3329 | 3dayblinds.com